

Extruded Aluminum Enclosures (Plastic End Panels) (1455 Series)

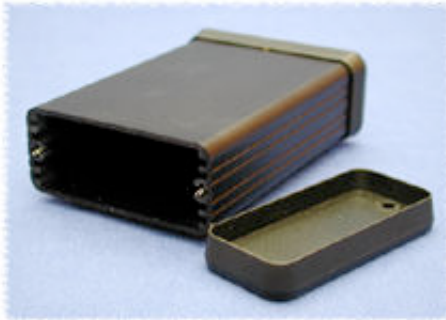

**Black Anodized
(Open View)**



**Black Anodized
(Assembled View)**







































**Clear Anodized
(Assembled View)**













































Key Features:

- Designed to house P.C. boards or for equipment interfacing.
- Sized for standard Eurocards.
- P.C. boards mount horizontally by sliding into internal slots extruded into the enclosure body.
- Rugged body constructed from extruded aluminum with a minimum thickness of .06" (1.5 mm).
- Extruded body includes a slide removable "belly" plate - except in smaller "A", "B" and "C" sizes (ie...1455A802, 1455B1202 sizes etc.) see  ["photo tables"](#) for more visual details.
- Smaller sizes ("A" & "B") are rounded for better hand held ergonomics.

Includes:

- Two easy to machine, black solid ABS plastic end panels with integral bezel (link here if you prefer our [metal end panel version](#))
- Extruded, anodized aluminum body (choice of either clear or black)
- All hardware and rubber feet
- **NOTE:** Recommended screw torque is 5 lbf/in











Part Number	Aluminum Anodized Color	 PDF Reader File	 AutoCAD .dwg Files (zipped)	 3D Solid Model .igs & .stp files (zipped)	Units	Length	Width	Height
1455A802 1455A802BK	Clear	 109K	 125K	 121K	Inches	3.15	2.76	0.47
	Black				mm	80	70	12
1455B802 1455B802BK	Clear	 220K	 129K	 136K	Inches	3.15	2.82	0.75
	Black				mm	80	71.7	19
1455C802 1455C802BK	Clear	 220K	 134K	 111K	Inches	3.15	2.13	0.91
	Black				mm	80	54	23
1455A1002 1455A1002BK	Clear	 203K	 124K	 121K	Inches	3.94	2.76	0.47
	Black				mm	100	70	12
1455B1002 1455B1002BK	Clear	 216K	 124K	 136K	Inches	3.94	2.82	0.75
	Black				mm	100	71.7	19
1455A1202 1455A1202BK	Clear	 203K	 126K	 121K	Inches	4.72	2.76	0.47
	Black				mm	120	70	12
1455B1202 1455B1202BK	Clear	 223K	 125K	 136K	Inches	4.72	2.82	0.75
	Black				mm	120	71.7	19
1455C1202 1455C1202BK	Clear	 216K	 130K	 111K	Inches	4.72	2.13	0.91
	Black				mm	120	54	23
1455J1202 1455J1202BK	Clear	 249K	 145K	 203K	Inches	4.72	3.07	1.06
	Black				mm	120	78	27
1455K1202 1455K1202BK	Clear	 345K	 152K	 212K	Inches	4.72	3.07	1.69
	Black				mm	120	78	43
1455L1202 1455L1202BK	Clear	 264K	 149K	 206K	Inches	4.72	4.06	1.20
	Black				mm	120	103	30.5



















1455N1202 1455N1202BK	Clear Black	 258K	 149K	 226K	Inches mm	4.72 120	4.06 103	2.09 53
1455J1602 1455J1602BK	Clear Black	 255K	 156K	 203K	Inches mm	6.30 160	3.07 78	1.06 27
1455K1602 1455K1602BK	Clear Black	 245K	 152K	 212K	Inches mm	6.30 160	3.07 78	1.69 43
1455L1602 1455L1602BK	Clear Black	 264K	 148K	 206K	Inches mm	6.30 160	4.06 103	1.20 30.5
1455N1602 1455N1602BK	Clear Black	 244K	 149K	 227K	Inches mm	6.30 160	4.06 103	2.09 53
1455P1602 1455P1602BK	Clear Black	 261K	 147K	 215K	Inches mm	6.30 160	4.92 125	1.20 30.5
1455Q1602 1455Q1602BK	Clear Black	 279K	 153K	 256K	Inches mm	6.30 160	4.92 125	2.03 51.5
1455R1602 1455R1602BK	Clear Black	 162K	 123K	 288K	Inches mm	6.30 160	6.50 165	1.2 30.5
1455T1602 1455T1602BK	Clear Black	 163K	 125K	 256K	Inches mm	6.30 160	6.50 165	2.1 51.5
1455L2202 1455L2202BK	Clear Black	 269K	 150K	 206K	Inches mm	8.66 220	4.06 103	1.20 30.5
1455N2202 1455N2202BK	Clear Black	 247K	 148K	 227K	Inches mm	8.66 220	4.06 103	2.09 53
1455P2202 1455P2202BK	Clear Black	 250K	 148K	 215K	Inches mm	8.66 220	4.92 125	1.20 30.5
1455Q2202 1455Q2202BK	Clear Black	 375K	 155K	 256K	Inches mm	8.66 220	4.92 125	2.03 51.5
1455R2202 1455R2202BK	Clear Black	 149K	 124K	 288K	Inches mm	8.66 220	6.50 165	1.2 30.5
1455T2202 1455T2202BK	Clear Black	 166K	 128K	 256K	Inches mm	8.66 220	6.50 165	2.1 51.5

Wallmount Options:



- Designed to convert these enclosures where shelf or wall mounting is required
- Flanges are .064" (1.6 mm) thick aluminum foot "L" brackets and attach to each end, replacing the plastic end panels
- Finish available in both clear & black anodized to match enclosure
- **SOLD IN PAIRS**

Part Number	Color	 Reader File	AutoCAD .dwg Files (zipped)	3D Solid Model .igs & .stp files (zipped)	USE WITH ENCLOSURE
1455CF 1455CFBK	Clear Black	 142K	 94K	 24K	Any part above starting with 1455C
1455JF 1455JFBK	Clear Black	 174K	 83K	 25K	Any part above starting with 1455J
1455KF 1455KFBK	Clear Black	 159K	 118K	 25K	Any part above starting with 1455K

1455LF 1455LFBK	Clear Black	 160K	 110K	 25K	Any part above starting with 1455L
1455NF 1455NFBK	Clear Black	 165K	 111K	 25K	Any part above starting with 1455N
1455PF 1455PFBK	Clear Black	 180K	 112K	 24K	Any part above starting with 1455P
1455QF 1455QFBK	Clear Black	 145K	 113K	 25K	Any part above starting with 1455Q
1455RF 1455RFBK	Clear Black	 143K	 111K	 25K	Any part above starting with 1455R
1455TF 1455TFBK	Clear Black	 150K	 111K	 25K	Any part above starting with 1455T

Replacement Parts & Bezel Options:



Black Plastic - Solid Bezel

USE WITH (Enclosure Part Number)	Black Plastic Solid Bezel	
	(2 Pack)	(10 Pack)
1455C802	1455CPLBK	1455CPLBK-10
1455C1202	1455CPLBK	1455CPLBK-10
1455J1202	1455JPLBK	1455JPLBK-10
1455K1202	1455KPLBK	1455KPLBK-10
1455L1202	1455LPLBK	1455LPLBK-10
1455N1202	1455NPLBK	1455NPLBK-10
1455J1602	1455JPLBK	1455JPLBK-10
1455K1602	1455KPLBK	1455KPLBK-10
1455L1602	1455LPLBK	1455LPLBK-10
1455N1602	1455NPLBK	1455NPLBK-10
1455P1602	1455PPLBK	1455PPLBK-10
1455Q1602	1455QPLBK	1455QPLBK-10
1455R1602	1455RPLBK	1455RPLBK-10
1455T1602	1455TPLBK	1455TPLBK-10
1455L2202	1455LPLBK	1455LPLBK-10
1455N2202	1455NPLBK	1455NPLBK-10
1455P2202	1455PPLBK	1455PPLBK-10
1455Q2202	1455QPLBK	1455QPLBK-10
1455R2202	1455RPLBK	1455RPLBK-10
1455T2202	1455TPLBK	1455TPLBK-10



(click to enlarge)

Red ABS Plastic - Solid Bezel



(click to enlarge)

Yellow ABS Plastic - Solid Bezel

USE WITH (Enclosure Part Number)	Red		Yellow	
	(2 Pack)	(10 Pack)	(2 Pack)	(10 Pack)
1455C802	1455CPLRED	1455CPLRED-10	1455CPLY	1455CPLY-10
1455C1202	1455CPLRED	1455CPLRED-10	1455CPLY	1455CPLY-10
1455J1202	1455JPLRED	1455JPLRED-10	1455JPLY	1455JPLY-10
1455K1202	1455KPLRED	1455KPLRED-10	1455KPLY	1455KPLY-10
1455L1202	1455LPLRED	1455LPLRED-10	1455LPLY	1455LPLY-10
1455N1202	1455NPLRED	1455NPLRED-10	1455NPLY	1455NPLY-10
1455J1602	1455JPLRED	1455JPLRED-10	1455JPLY	1455JPLY-10
1455K1602	1455KPLRED	1455KPLRED-10	1455KPLY	1455KPLY-10
1455L1602	1455LPLRED	1455LPLRED-10	1455LPLY	1455LPLY-10
1455N1602	1455NPLRED	1455NPLRED-10	1455NPLY	1455NPLY-10
1455P1602	1455PPLRED	1455PPLRED-10	1455PPLY	1455PPLY-10
1455Q1602	1455QPLRED	1455QPLRED-10	1455QPLY	1455QPLY-10
1455R1602	1455RPLRED	1455RPLRED-10	1455RPLY	1455RPLY-10
1455T1602	1455TPLRED	1455TPLRED-10	1455TPLY	1455TPLY-10
1455L2202	1455LPLRED	1455LPLRED-10	1455LPLY	1455LPLY-10
1455N2202	1455NPLRED	1455NPLRED-10	1455NPLY	1455NPLY-10
1455P2202	1455PPLRED	1455PPLRED-10	1455PPLY	1455PPLY-10
1455Q2202	1455QPLRED	1455QPLRED-10	1455QPLY	1455QPLY-10
1455R2202	1455RPLRED	1455RPLRED-10	1455RPLY	1455RPLY-10
1455T2202	1455TPLRED	1455TPLRED-10	1455TPLY	1455TPLY-10



**Translucent Blue
Polycarbonate - Solid Bezel**

**Translucent (IR) Red
Polycarbonate - Solid Bezel**

USE WITH (Enclosure Part Number)	Translucent Blue		Translucent Red	
	(2 Pack)	(10 Pack)	(2 Pack)	(10 Pack)
1455C802	1455CPLTBU	1455CPLTBU-10	1455CPLTRD	1455CPLTRD-10
1455C1202	1455CPLTBU	1455CPLTBU-10	1455CPLTRD	1455CPLTRD-10
1455J1202	1455JPLTBU	1455JPLTBU-10	1455JPLTRD	1455JPLTRD-10
1455K1202	1455KPLTBU	1455KPLTBU-10	1455KPLTRD	1455KPLTRD-10
1455L1202	1455LPLTBU	1455LPLTBU-10	1455LPLTRD	1455LPLTRD-10
1455N1202	1455NPLTBU	1455NPLTBU-10	1455NPLTRD	1455NPLTRD-10
1455J1602	1455JPLTBU	1455JPLTBU-10	1455JPLTRD	1455JPLTRD-10
1455K1602	1455KPLTBU	1455KPLTBU-10	1455KPLTRD	1455KPLTRD-10
1455L1602	1455LPLTBU	1455LPLTBU-10	1455LPLTRD	1455LPLTRD-10
1455N1602	1455NPLTBU	1455NPLTBU-10	1455NPLTRD	1455NPLTRD-10
1455P1602	1455PPLTBU	1455PPLTBU-10	1455PPLTRD	1455PPLTRD-10
1455Q1602	1455QPLTBU	1455QPLTBU-10	1455QPLTRD	1455QPLTRD-10
1455R1602	1455RPLTBU	1455RPLTBU-10	1455RPLTRD	1455RPLTRD-10

1455T1602	1455TPLTBU	1455TPLTBU-10	1455TPLTRD	1455TPLTRD-10
1455L2202	1455LPLTBU	1455LPLTBU-10	1455LPLTRD	1455LPLTRD-10
1455N2202	1455NPLTBU	1455NPLTBU-10	1455NPLTRD	1455NPLTRD-10
1455P2202	1455PPLTBU	1455PPLTBU-10	1455PPLTRD	1455PPLTRD-10
1455Q2202	1455QPLTBU	1455QPLTBU-10	1455QPLTRD	1455QPLTRD-10
1455R2202	1455RPLTBU	1455RPLTBU-10	1455RPLTRD	1455RPLTRD-10
1455T2202	1455TPLTBU	1455TPLTBU-10	1455TPLTRD	1455TPLTRD-10

Copyright; © 2002-2009 Hammond Mfg Co Inc

URL: <http://www.hammondmfg.com>

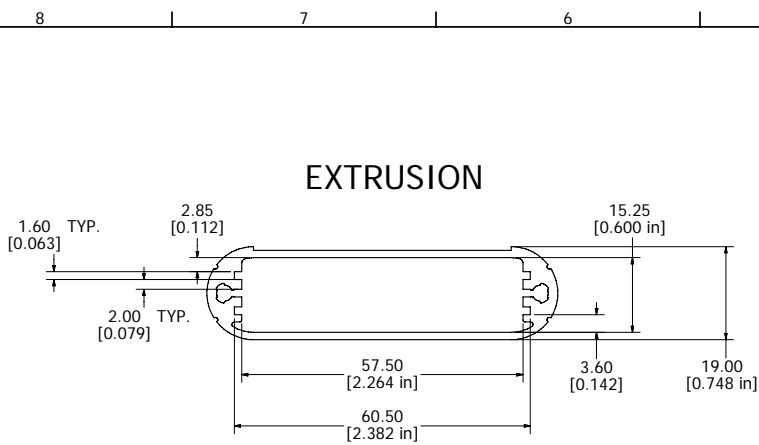

Extrusion designed for 60mm wide x 80mm long PCBs.

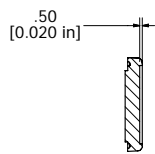
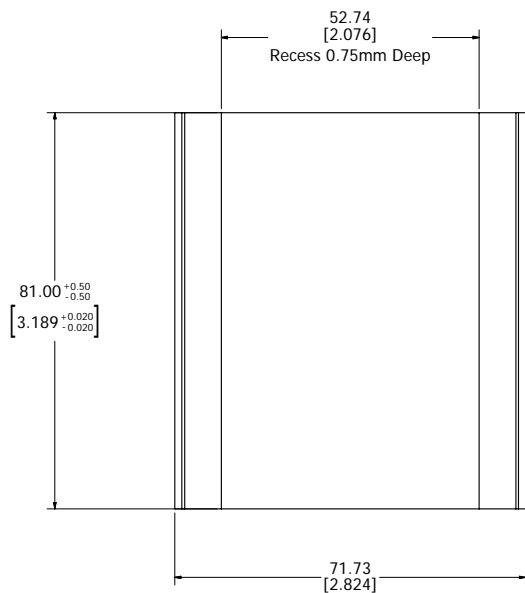
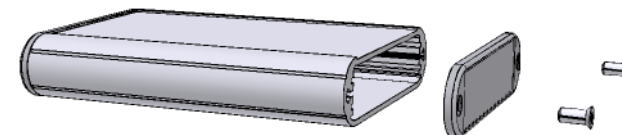

SECTION A-A

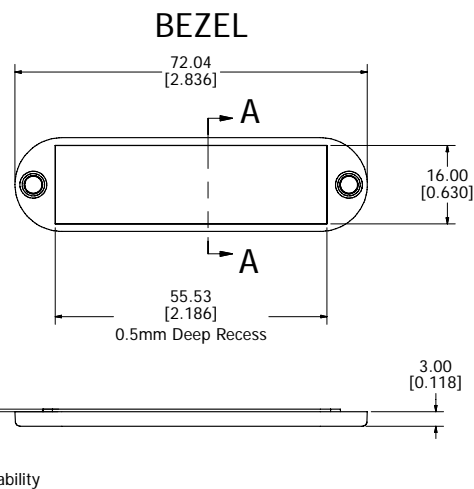

Extends into Extrusion for stability

Enclosures can be Factory Modified (Milling, Drilling, Printing etc.)
Solid models of this enclosure available in STEP or IGES.
Contact Factory mjm@hammondmfg.com

NOTE	
Purchased assembly includes box, plastic bezels, #6 Taptight screws and self adhesive rubber feet.	
Box made from Extruded Aluminum 6063.	
Bezels made from polycarbonate.	

1455B802	
PART NUMBERS	
Clear Anodized	1455B802
Black Anodized	1455B802BK
ACCESSORIES	
See website for accessories.	

HAMMOND MANUFACTURING™
1455B802
www.hammondmfg.com